

JACK TWORIKOV, *Knight Series*, 1975



**RENDER**

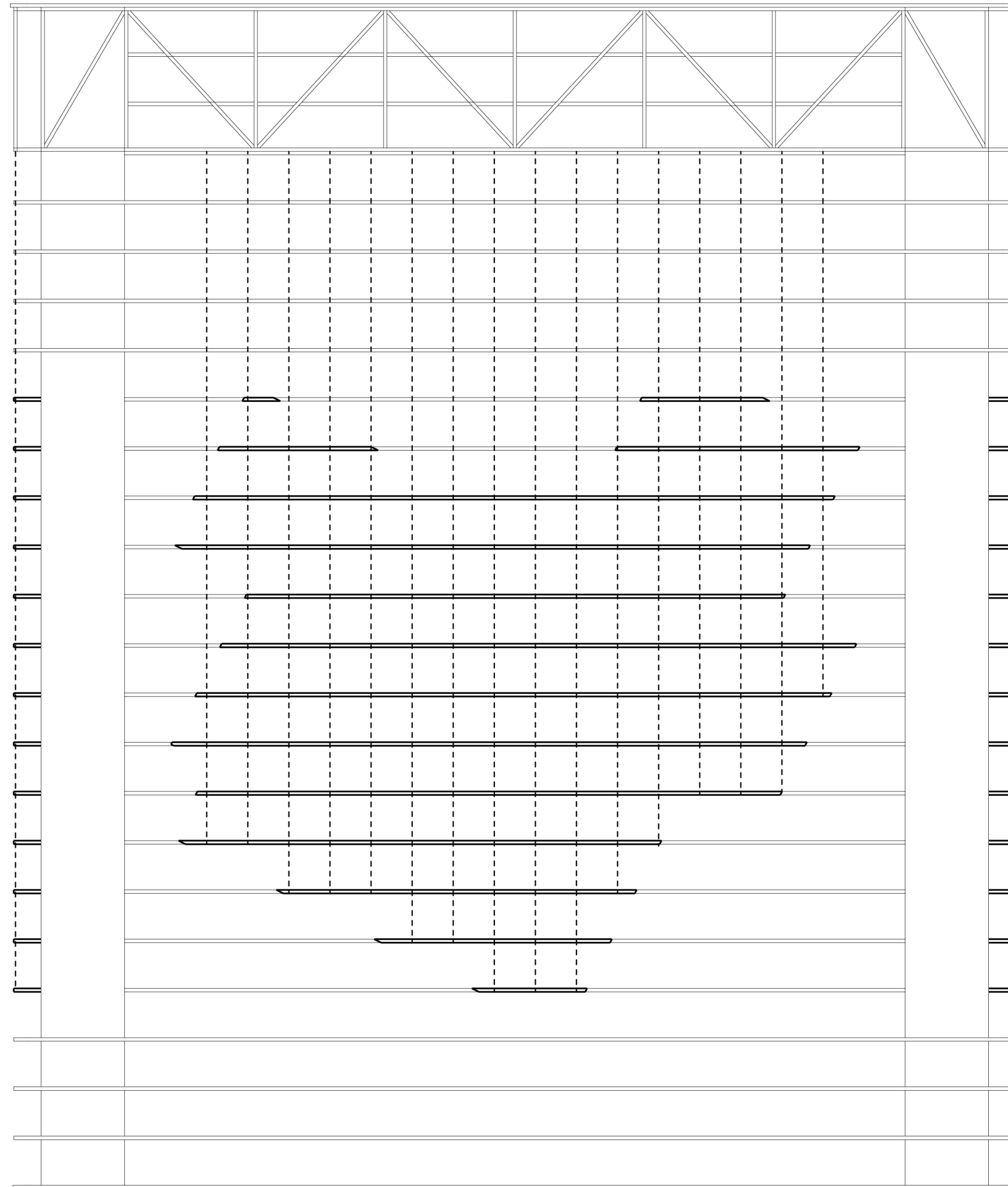

***SUPPORT DIAGRAM***

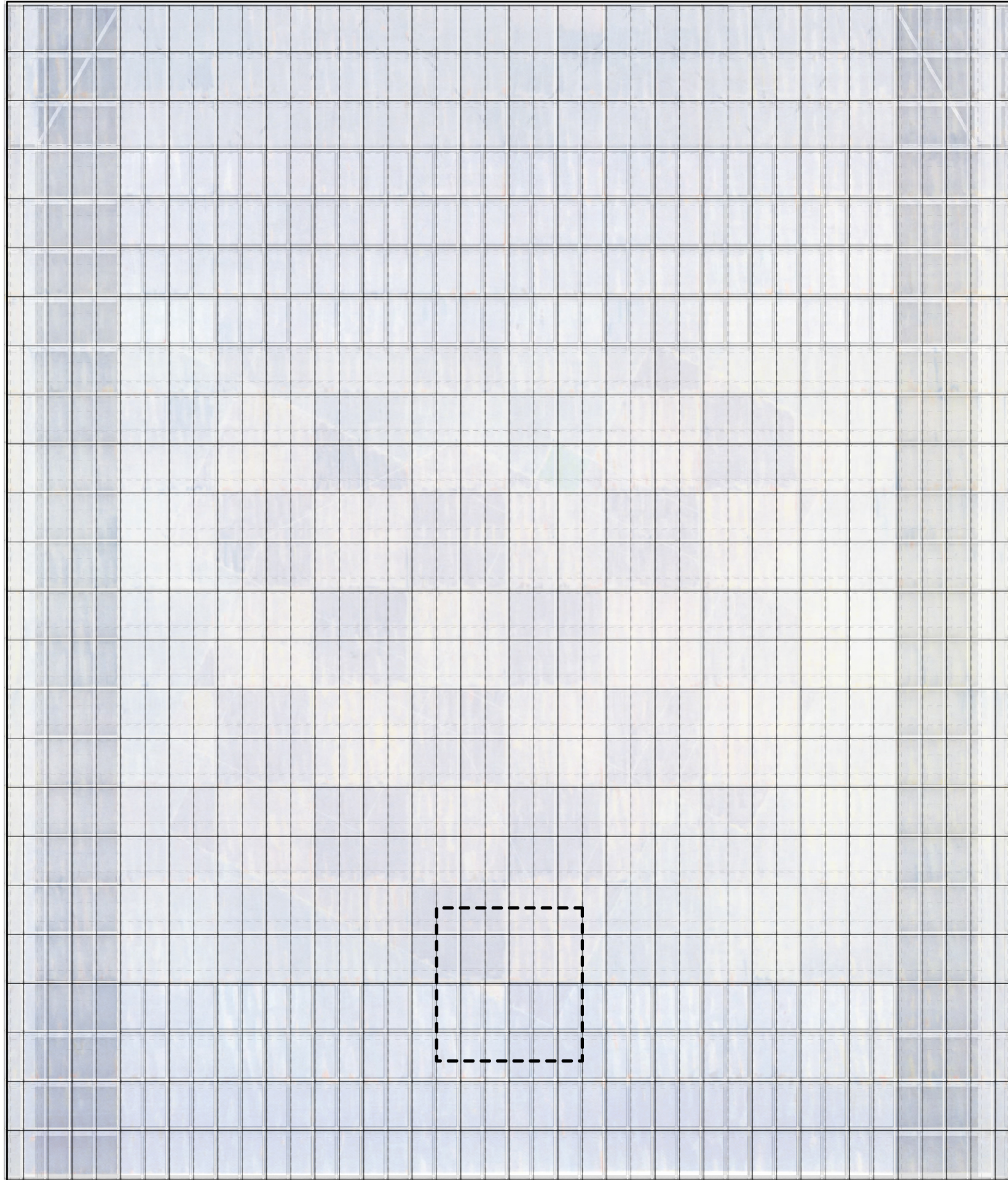

***ELEVATION***

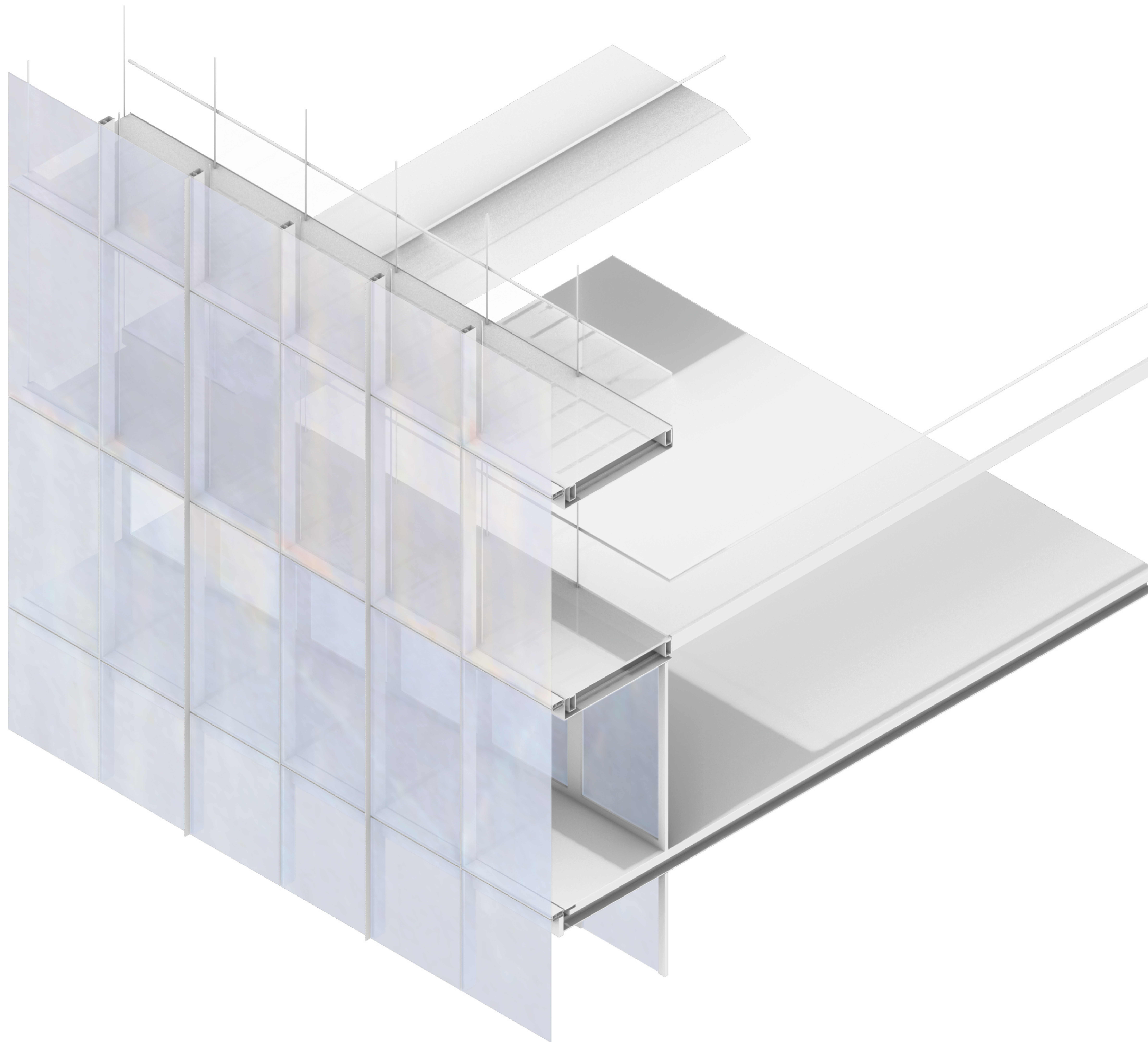

***ISOMETRIC: CLOSEUP***



**E1.0: ELEVATION**

**1/2" = 1'-0"**

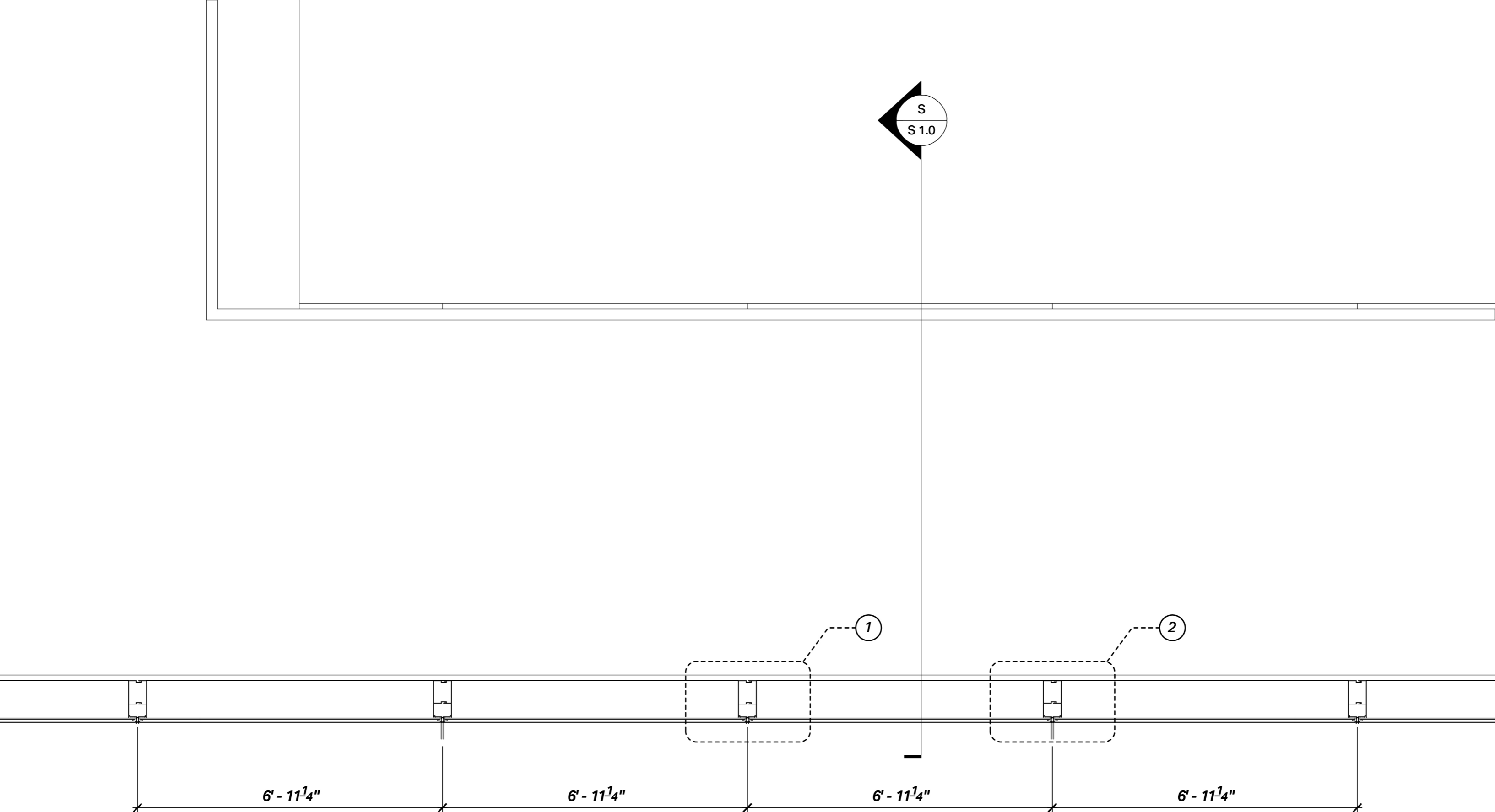

**PLAN**

**1/2" = 1'-0"**

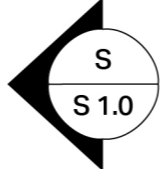
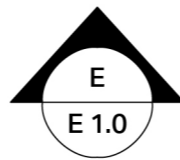

1

2

6' - 11<sup>1</sup>/<sub>4</sub>"

6' - 11<sup>1</sup>/<sub>4</sub>"

6' - 11<sup>1</sup>/<sub>4</sub>"

6' - 11<sup>1</sup>/<sub>4</sub>"

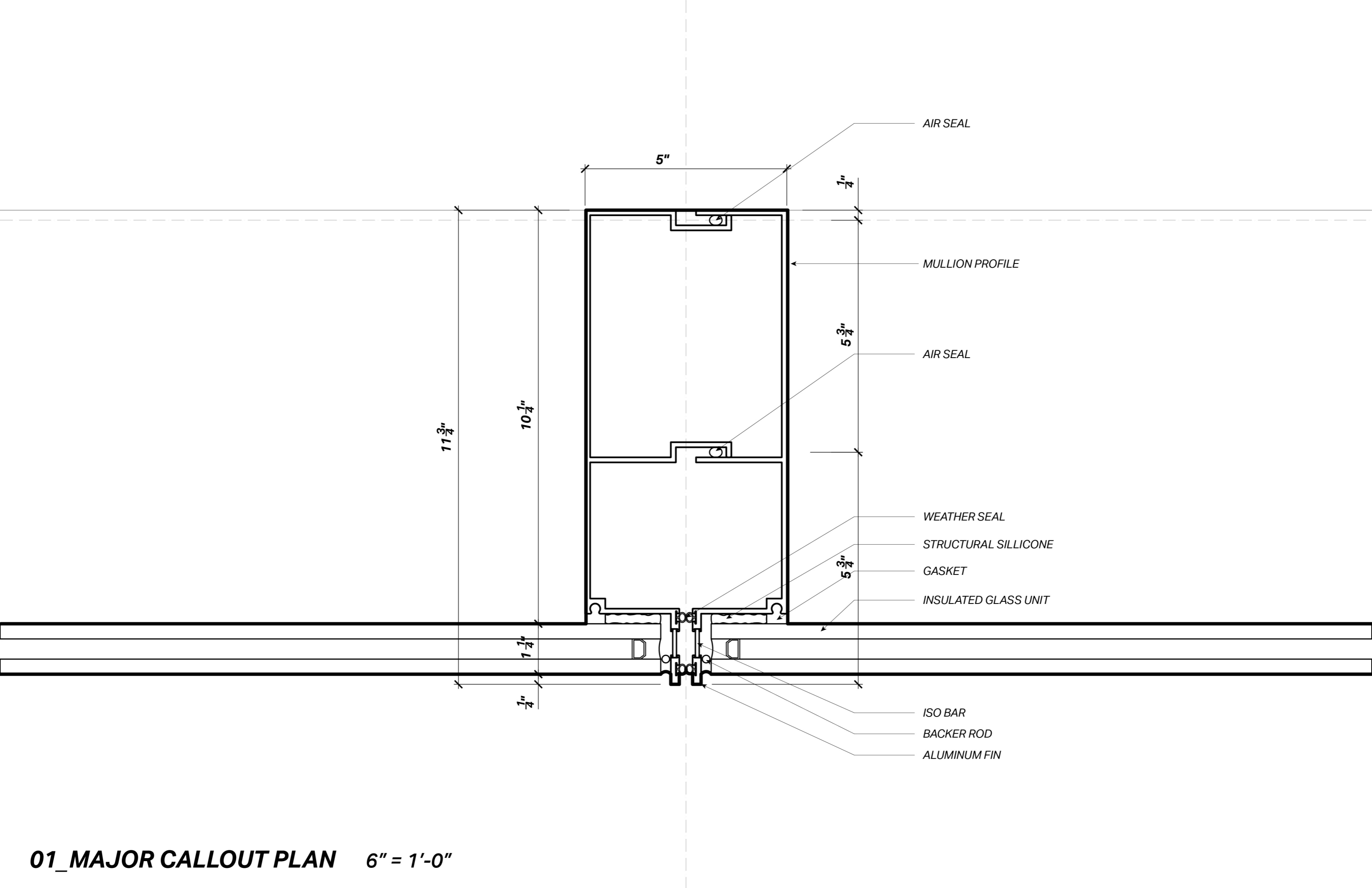

**01\_MAJOR CALLOUT PLAN** 6" = 1'-0"



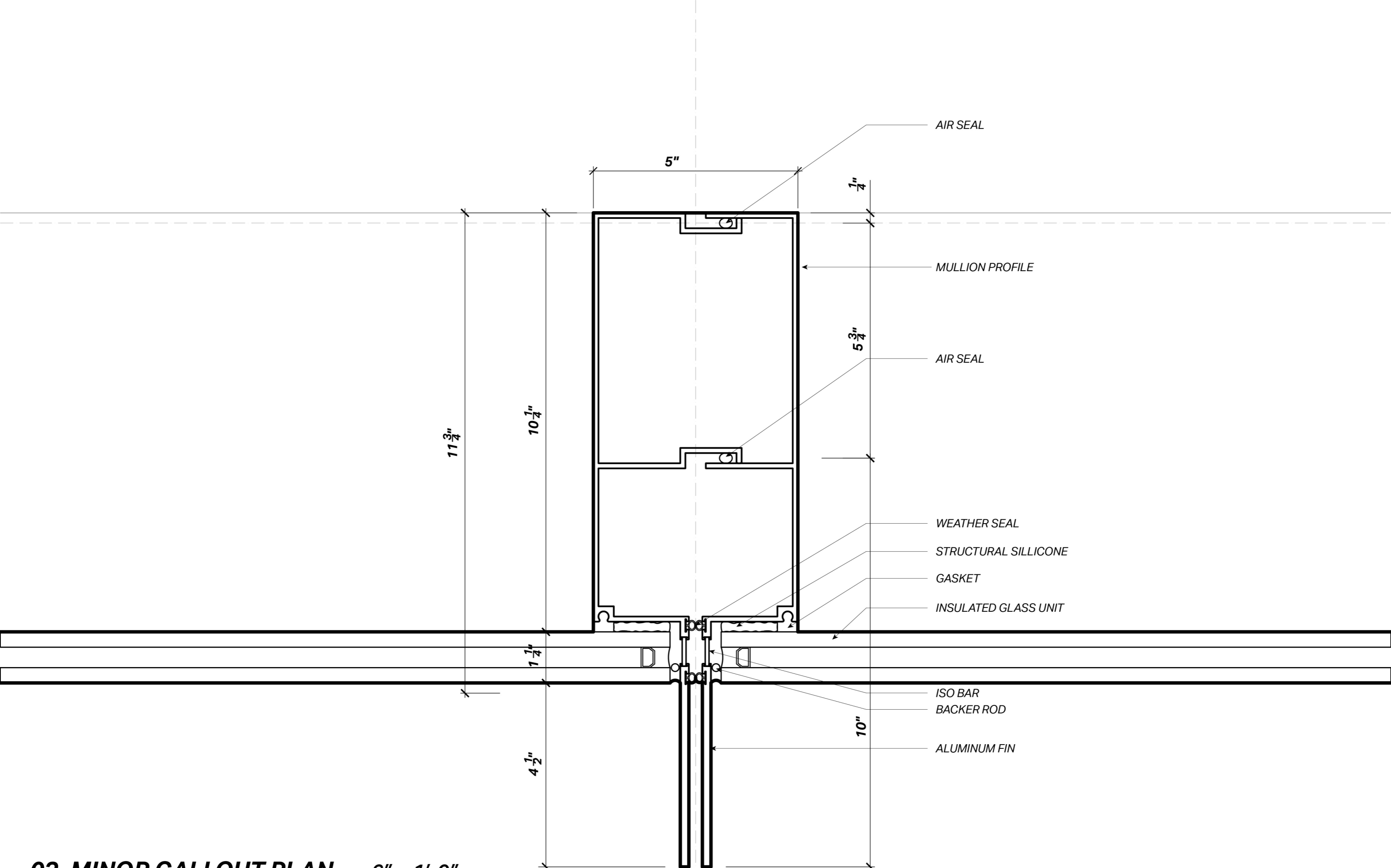

**02\_MINOR CALLOUT PLAN**     **6" = 1'-0"**

# ANCHOR PLAN\_GLASS WALKWAY

6" = 1'-0"

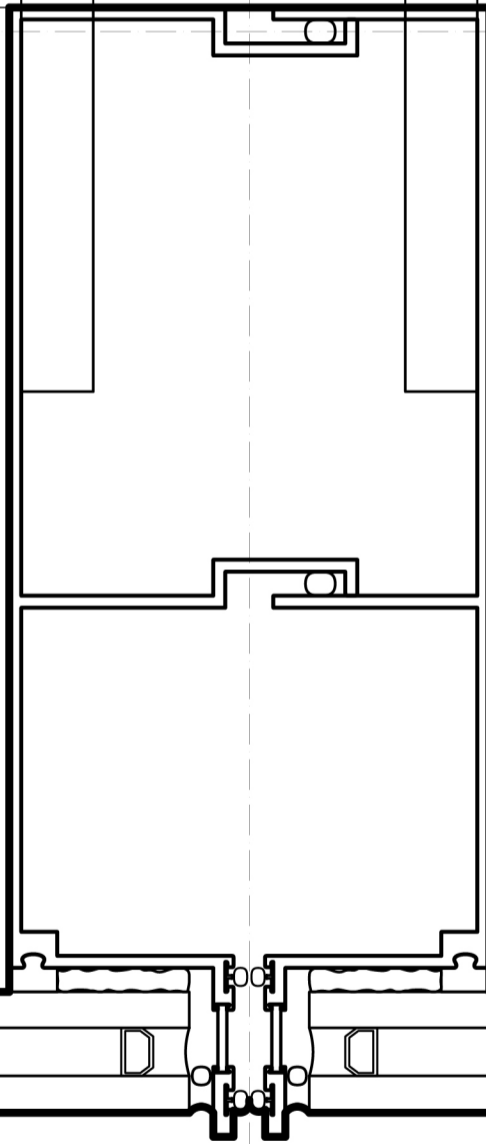
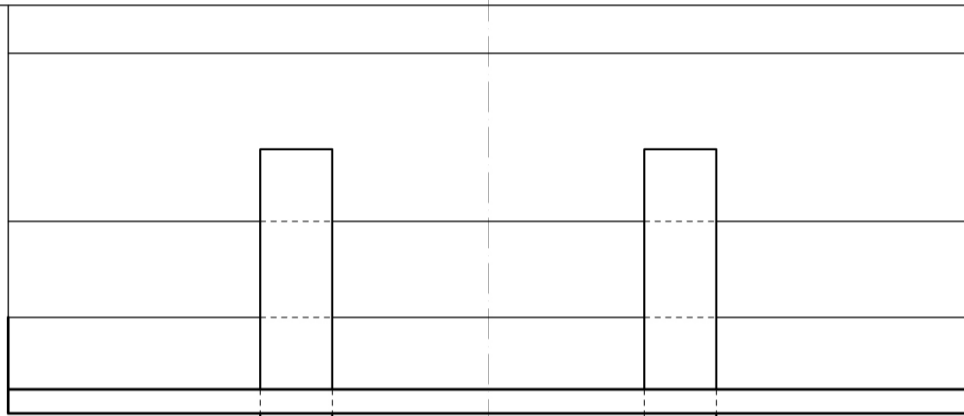

# ANCHOR PLAN\_CONCRETE SLAB

6" = 1'-0"

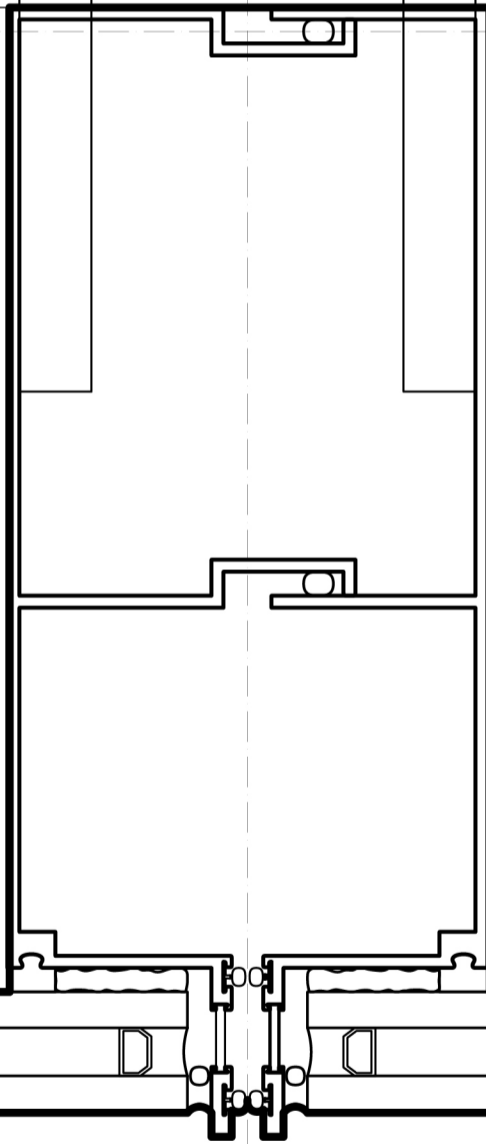
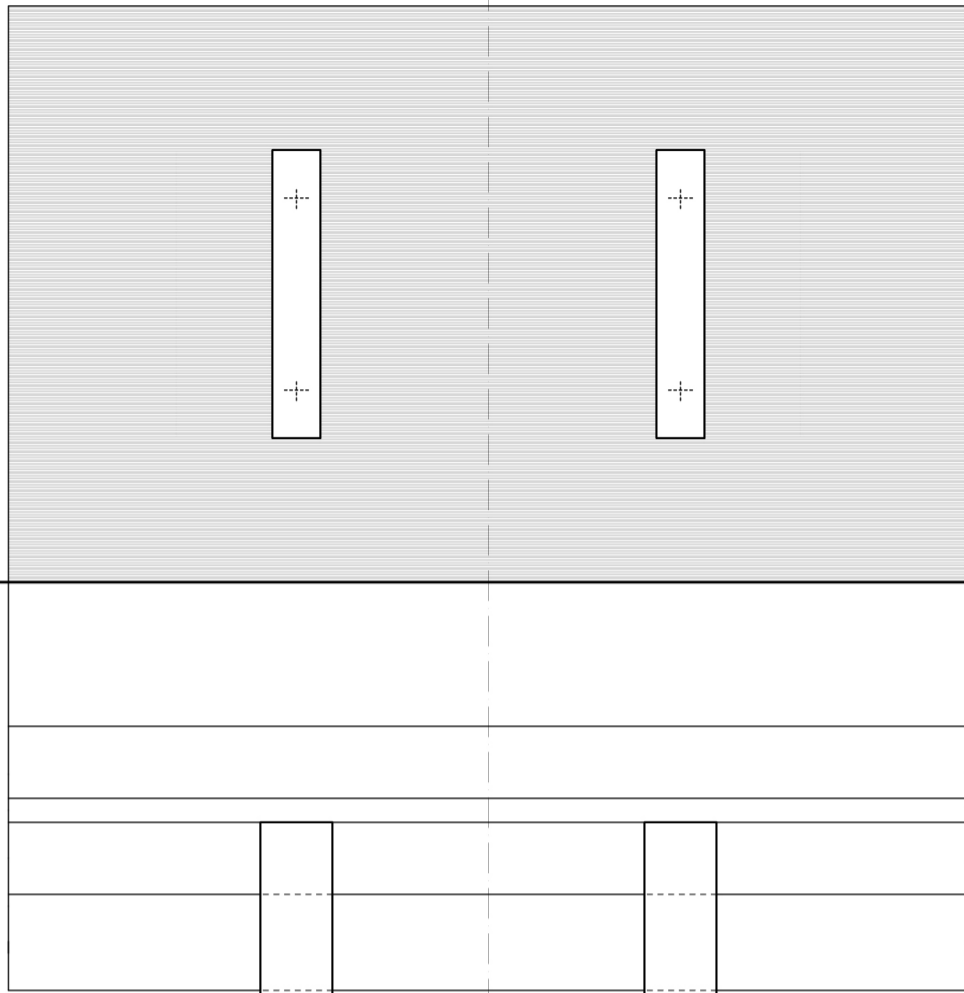

**S1.0 :SECTION** 1/2" = 1'-0"

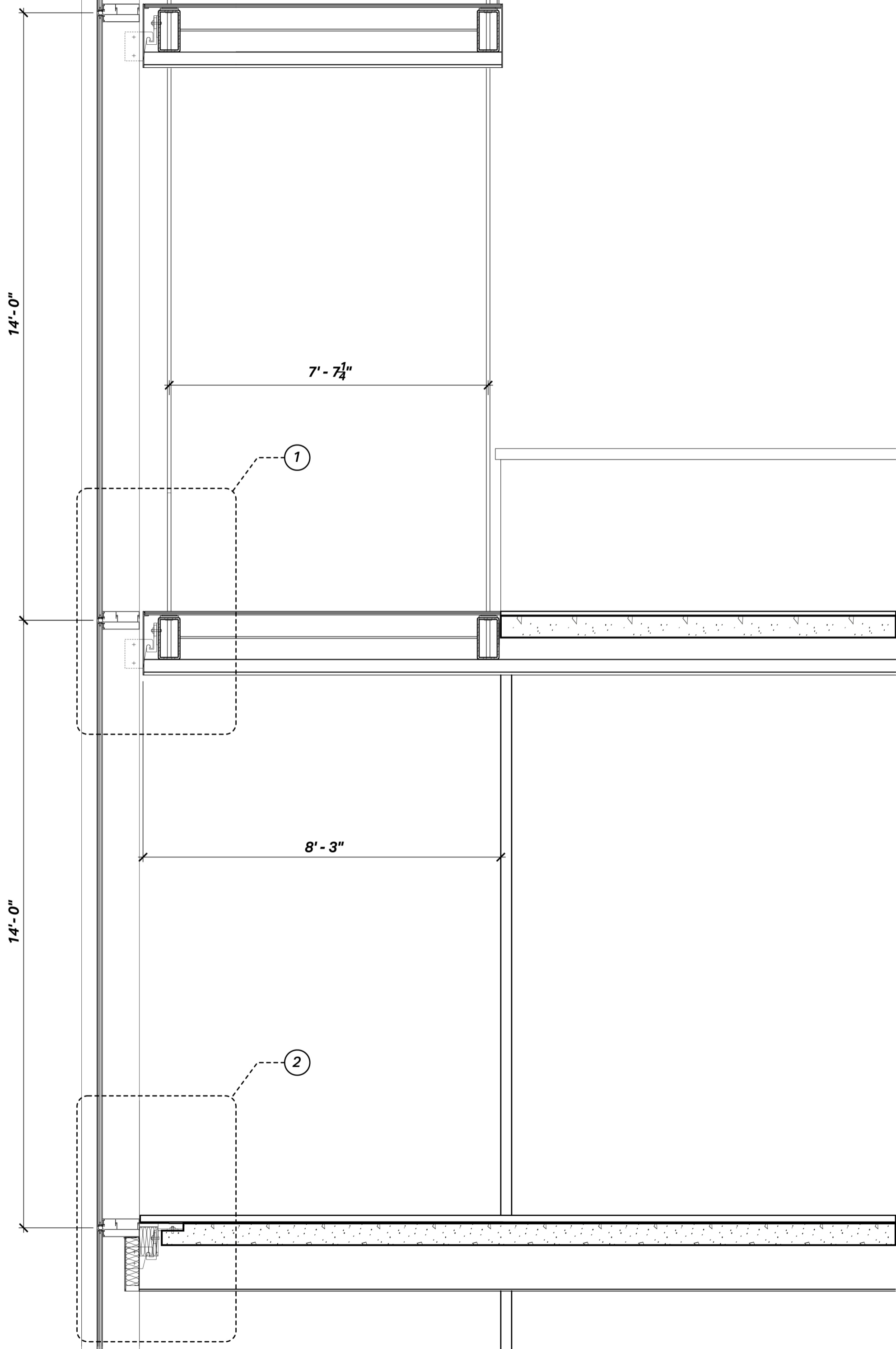

# 01\_CALLOUT SECTION

3" = 1'-0"

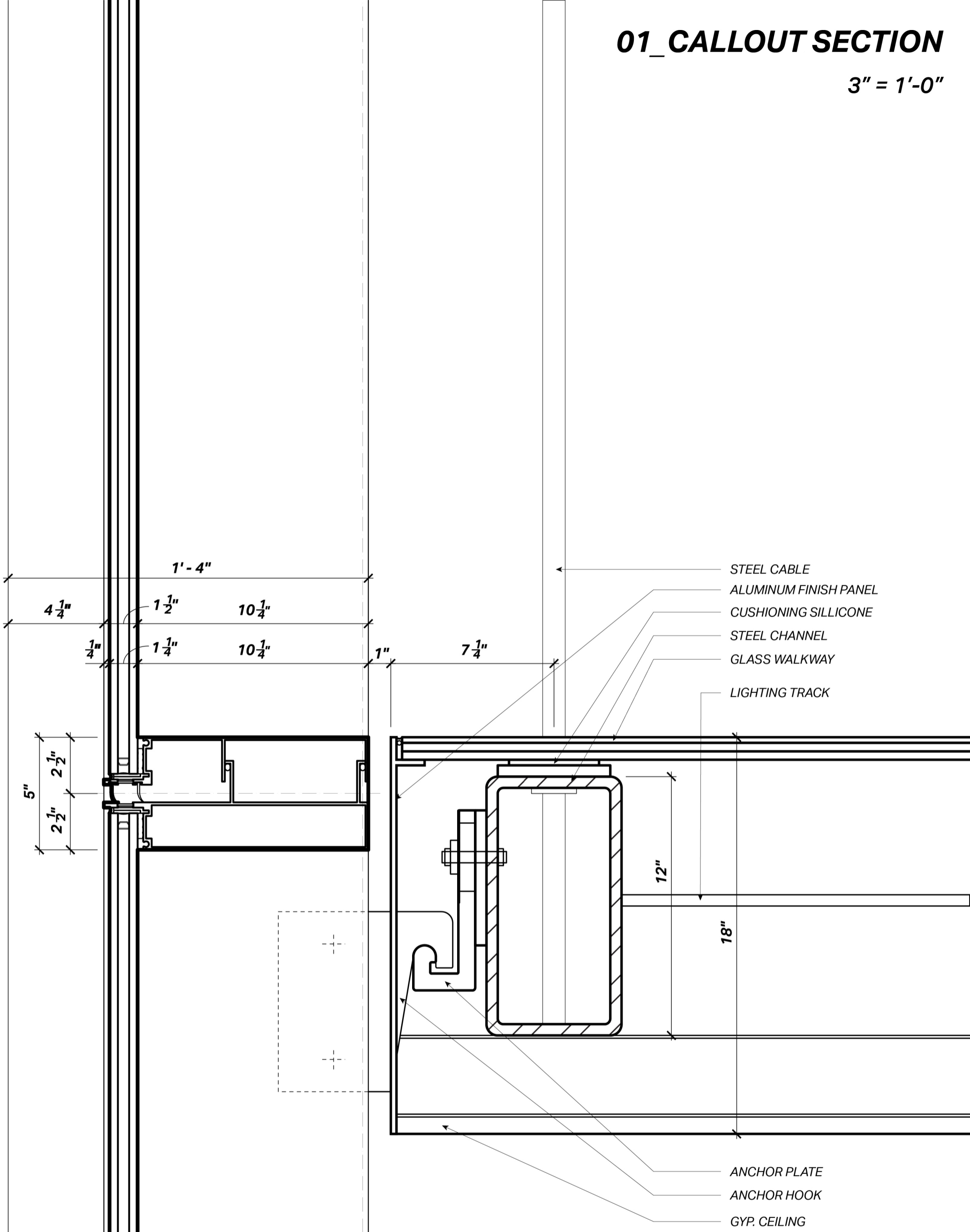

# 02\_CALLOUT SECTION

3" = 1'-0"

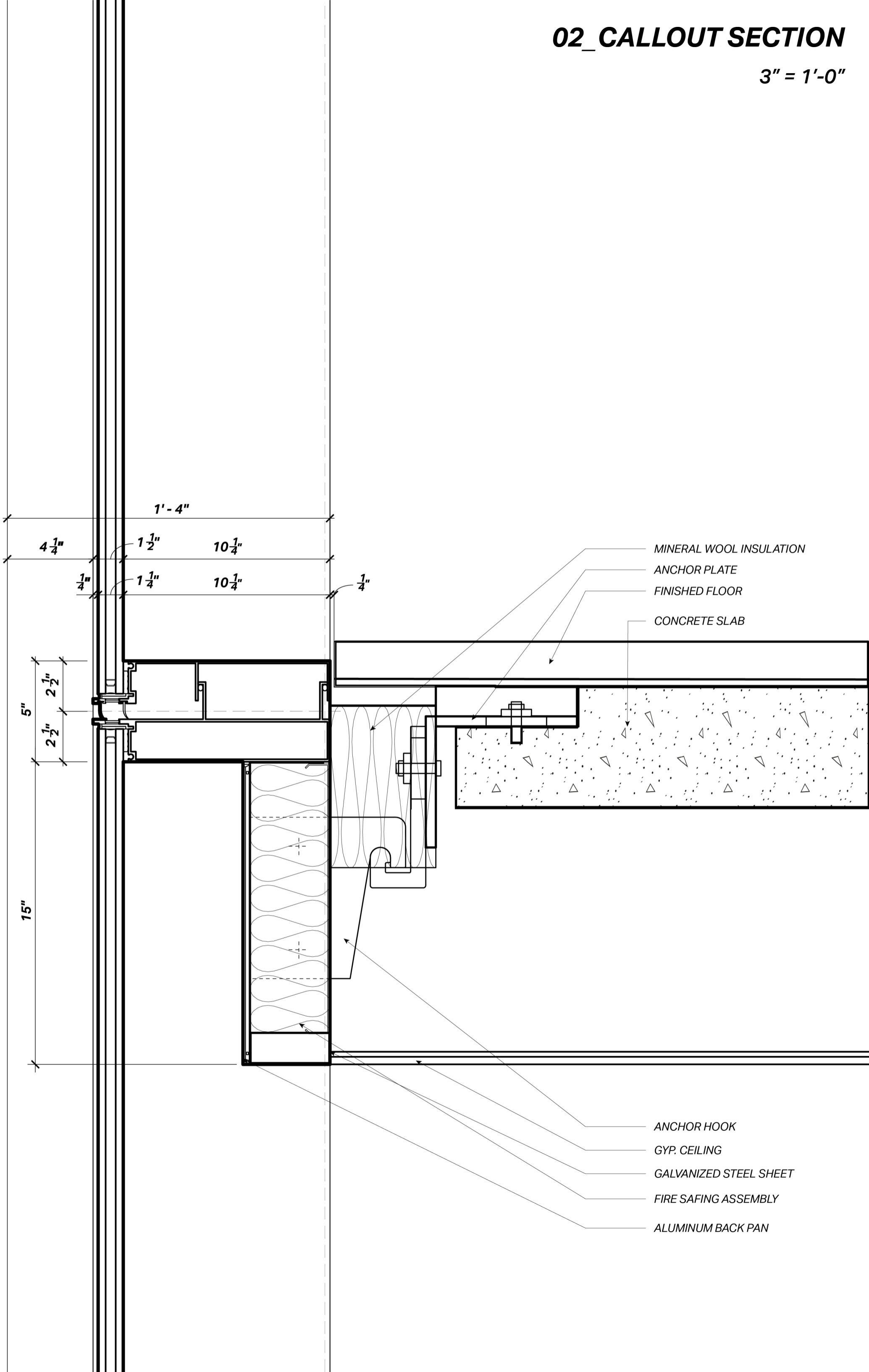

MINERAL WOOL INSULATION  
ANCHOR PLATE  
FINISHED FLOOR  
CONCRETE SLAB

ANCHOR HOOK  
GYP. CEILING  
GALVANIZED STEEL SHEET  
FIRE SAFING ASSEMBLY  
ALUMINUM BACK PAN

1'-4"

4 1/4"

1 1/2"

10 1/4"

1/4"

1 1/4"

10 1/4"

1/4"

5"  
2 1/2"  
2 1/2"

15"